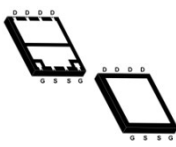
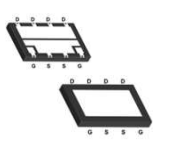
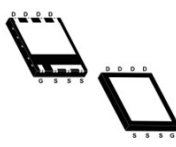
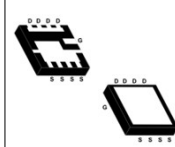
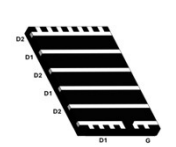
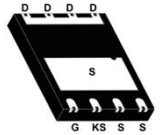

E-mode 40V-200V

E-mode 700V

Package	GR 5060E (DFN 5x6)	GR 5030E (DFN 5x3)	5060E P2P (RQFN 5x6)	3030E P2P (RQFN 3x3)	BDS (QFN 4X6)
Pinout	 ※ Double Side Cooling	 ※ Double Side Cooling	 ※ Double Side Cooling	 ※ Double Side Cooling	
Part-number (40V)	-	GR-04E001UG	GR-04E001DJ	GR-04E001GJ	-
Part-number (100V)	GR-10E001DG GR-10E003DG	GR-10E003UG GR-10E005UG	GR-10E001DJ GR-10E003DJ GR-10E005DJ	GR-10E003GJ	GR-10M003WQ
Part-number (150V)	GR-15E005DG GR-15E007DG	GR-15E003UG GR-15E005UG GR-15E007UG	GR-15E003DJ GR-15E005DJ GR-15E007DJ	GR-15E005GJ GR-15E007GJ	-
Part-number (200V)	GR-20E007DG GR-20E010DG	GR-20E007UG GR-20E010UG	GR-20E007DJ GR-20E010DJ	-	-

Package	5060E (DFN 5x6)
Pinout	
Part-number	GR-70E100DD GR-70E150DD GR-70E240DD GR-70E350DD

Power Stage

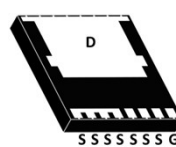
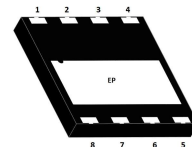
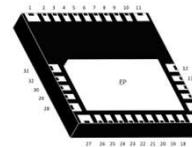
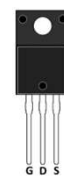
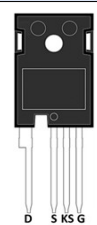
Package	TOLL9 (DFN 9.9x10.5)	8080L (DFN 8x8)		8080Q (QFN 8x8)	TO-220F	TO-247-4
Pinout						
Type	650V P2P 3Pin GaN IC	650V Integrated Cascade GaN	650V Integrated E-mode GaN	650V GaN Power Stage	650V P2P 3Pin GaN IC	650V P2P 3Pin GaN IC
Part-number	GR-65K075ED GR-65K100ED GR-65K120ED GR-65K170ED	GR-65R170AD GR-65C170AD	GR-65N150AD GR-65T150AD	GR-65Q170AQ GR-65Q240AQ	GR-65K120JF GR-65K170JF	GR-65K075KT GR-65K100KT GR-65K120KT GR-65K170KT

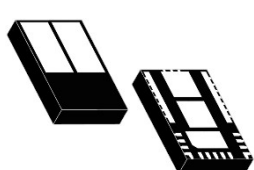
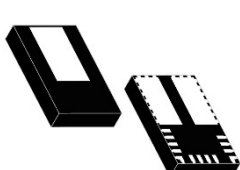
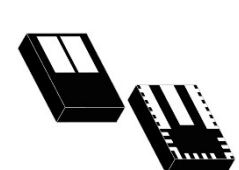
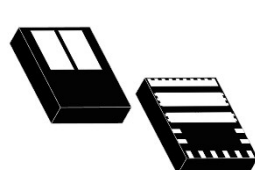
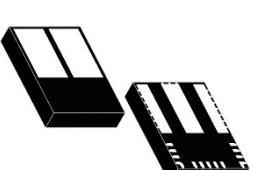
Package	GR-QFN (4.5 x 7.0)	GR-QFN (4.0 x 6.5)	GR-QFN (3.5 x 5.0)	GR-QFN (5.0 x 6.5)	GR-QFN (5.0 x 7.0)
Pinout	 ※ Double Side Cooling	 ※ Double Side Cooling	 ※ Double Side Cooling	 ※ Double Side Cooling	 ※ Double Side Cooling
Type	E-mode with Integrated Driver (P2P TI LMG2100)	E-mode with Integrated Driver (P2P TI LMG3100)	E-mode with Integrated Driver (P2P EPC EPC23104)	E-mode with Integrated Driver (P2P ISG3204)	E-mode with Integrated Driver (GR HB GaN)
Part-number	GR-10X003YQ	GR-10Y002ZQ GR-10Y005ZQ	GR-10Z011FQ	GR-10W003DQ	GR-10Z003YQ





Let's GaN access to innovation!

GaNrich

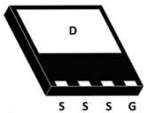
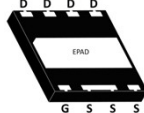
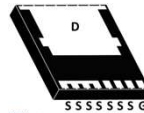

Cascode SMD 650V

TOLT

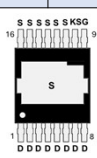

Package	8080CM (DFN 8x8)	8080M (DFN 8x8)		TOLL9 (DFN 9.9x10.5)	TOLL(MOS)
Pinout	 ※ Compatible with Si/SiC Device	 ※ Compatible with GaN Device		 ※ Compatible with Si/SiC Device	 ※ Compatible with Si/SiC Device
Part-number	Vth 3.0V	Vth 1.7V	Vth 3.0V	Vth 3.0V	Vth 3.0V
	GR-65J050AK GR-65J075AK GR-65J100AK GR-65J150AK	GR-65P075AM GR-65P100AM GR-65P150AM GR-65P240AM	GR-65J075AM GR-65J100AM GR-65J150AM GR-65J240AM	GR-65J050ED GR-65J075ED GR-65J100ED GR-65J150ED	GR-65J016MS GR-65J035MS GR-65J050MS GR-65J075MS

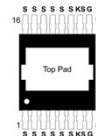
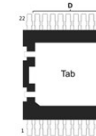
Package	TOLT (Cascode)	TOLT (E-mode)
Pinout		
Part-number	650V/Vth 3.0V	650V
	GR-65J016SL GR-65J035SL GR-65J050SL GR-65J075SL GR-65J100SL	GR-65E018SL GR-65E035SL GR-65E050SL

TOLT(BDS) & QDPAK

Package	TOLT(BDS)		QDPAK(Cascode)		QDPAK(BDS)	
Pinout	 *Top Pad : Isolation to Heatsink					
Part-number	D-mode 650V	E-mode 650V	650V	1200V	E-mode 650V	D-mode 1200V
	GR-65L100SL	GR-65M030SL GR-65M050SL GR-65M070SL GR-65M100SL	GR-65J016TI GR-65J035TI	GR-A2J035TI GR-A2J050TI GR-A2J075TI GR-A2J100TI	GR-65M030TI GR-65M050TI GR-65M070TI GR-65M100TI	GR-A2L050TI GR-A2L075TI GR-A2L100TI

Cascode TO & THP Series

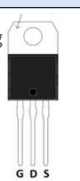
Package	TO-220F(D-tab)		TO-220F(S-tab)		IITO-220	
Pinout					 Insulation Slug	
Part-number	650V	900V	650V		650V	900V
	Vth 3.0V		Vth 1.7V	Vth 3.0V	Vth 3.0V	
	GR-65J075JF GR-65J100JF GR-65J150JF GR-65J240JF	GR-90J050JF GR-90J075JF GR-90J100JF	GR-65P075XF GR-65P100XF GR-65P150XF GR-65P240XF	GR-65J075XF GR-65J100XF GR-65J150XF GR-65J240XF	GR-65J075JZ GR-65J100JZ GR-65J150JZ GR-65J240JZ	GR-90J050JZ GR-90J075JZ GR-90J100JZ

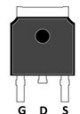
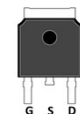
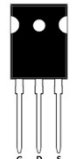
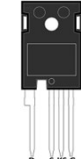
Package	TO-252(D-tab)	TO-252(S-tab)	TO-247-3			TO-247-4		
Pinout								
Part-number	650V/ Vth 3.0V	650V/ Vth 1.7V	650V	900V	1200V	650V	900V	1200V
	GR-65J150JA GR-65J240JA	GR-65P150XA GR-65P240XA	Vth 3.0V					
GR-65J150XA GR-65J240XA		GR-65J016JT GR-65J035JT GR-65J050JT GR-65J075JT GR-65J100JT	GR-90J035JT GR-90J050JT GR-90J075JT GR-90J100JT	GR-A2J035JT GR-A2J050JT GR-A2J075JT GR-A2J100JT	GR-65J016KT GR-65J035KT GR-65J050KT GR-65J075KT GR-65J100KT	GR-90J035KT GR-90J050KT GR-90J075KT GR-90J100KT	GR-A2J035KT GR-A2J050KT GR-A2J075KT GR-A2J100KT	