

GR-20E007DJ: E-mode GaN Power Transistor

Description

GR-20E007DJ is an enhancement mode GaN on Silicon power transistor. 20E007DJ provides, high current and high operating speed which is suitable for DC to DC power supply applications.

Key Specifications

Part Number	GR-20E007DJ
V _{DSS} , min.	200V
I _{DS} , Pulse (25°C, TPULSE = 300 μs)	180A
R _{DS(ON)} , typ. @V _{gs} =6V	7.3mΩ
Q _G , typ.	8.2nC

Features

- 200V enhancement mode power transistor
- High operating frequency
- R_{DS(on)} = Typ. 7.3mΩ
- RoHS compliant
- Zero QRR.

Applications

- Switch Mode Power Supplies (SMPS)
- DC-DC Converters
- Fast Battery Charging
- Appliance Motor Drives

GR-20E007DJ, RQFN-5x6-8L

Drain	5, 6, 7, 8
Gate	4
Source	1, 2, 3

1- Electrical Characteristics

➤ **Table 1 Absolute maximum ratings**

Symbol	Parameter	Value	Unit
V_{DSS}	Drain-source voltage	200	V
$V_{(TR)DSS}$	Transient drain to source voltage ^a	240	V
V_{GSS}	Gate- source voltage	-6V ~ +6V	V
I_D	Drain current (continuous) at $T_C = 25^\circ\text{C}$ operation	60	A
	Drain current (continuous) at $T_C = 100^\circ\text{C}$ operation	41.4	A
$I_{D,pulse}$	Pulsed drain current (pulse width: 300 μs , $V_{gs}=5\text{V}$) ^b	180	A
T_J	Operating temperature	-40 to +150	$^\circ\text{C}$
T_S	Storage temperature	-40 to +150	$^\circ\text{C}$
MSL	Moisture sensitivity level	MSL3	

a. In off-state, spike duty cycle $D < 0.01$, spike duration $< 1\mu\text{s}$

b. Defined by product design and characterization. Value is not tested to full current in production

➤ **Table 2 Thermal Characteristics**

Symbol	Parameter	Value	Unit
$R_{\theta JC_Top}$	Thermal resistance junction-case, Top	0.65	$^\circ\text{C}/\text{W}$
$R_{\theta JC_Bot}$	Thermal resistance junction-case, Bottom	0.50	$^\circ\text{C}/\text{W}$
$R_{\theta JA}$	Thermal resistance junction-ambient	60	$^\circ\text{C}/\text{W}$

a. Tested in package DFN-5x6.

➤ **Table 3 Electrical Characteristics** ($T_{CASE} = 25\text{ }^{\circ}\text{C}$ unless otherwise stated)

Symbol	Parameter	Conditions	Values			Unit
			min.	typ.	max.	
V_{DSS}	Drain-source voltage	$V_{GS} = 0V, I_D = 250\mu A$	200	-	-	V
$V_{GS(th)}$	Gate threshold voltage	$V_{DS} = V_{GS}, I_D = 1mA$	0.8	1.1	1.5	V
$R_{DS(on)}$	Drain-source on-resistance	$V_{GS} = 6V, I_D = 20A$	-	7.3	9.9	m Ω
I_{DSS}	Drain-source leakage current	$V_{DS} = 160V, V_{GS} = 0V$	-	5.0	400	μA
I_{GSS}	Gate-to-Source Forward Leakage current	$V_{GS} = +5V, T_J = 25^{\circ}\text{C}$	-	0.01	2.0	mA
	Gate-to-Source Forward Leakage current	$V_{GS} = +5V, T_J = 125^{\circ}\text{C}$	-	0.90	27.0	mA
	Gate-to-Source Reverse Leakage current	$V_{GS} = -4V, T_J = 25^{\circ}\text{C}$	-	0.008	0.24	mA
C_{ISS}	Input capacitance	$V_{DS} = 100V, V_{GS} = 0V$	-	700	-	pF
C_{OSS}	Output capacitance		-	340	-	
C_{RSS}	Reverse transfer capacitance		-	12.1	-	
Q_G	Gate charge	$V_{DS} = 100V, V_{GS} = 5V, I_D = 20A$	-	8.2	-	nC
Q_{GS}	Gate-source charge	$V_{DS} = 100V, I_D = 20A$	-	2.95	-	
Q_{GD}	Gate-drain charge		-	1.7	-	
Q_{OSS}	Output charge	$V_{DS} = 100V, V_{GS} = 0V$	-	58	-	
Q_{RR}	Source-Drain Recovery Charge	-	-	0	-	

2- Typical Characteristic Curves

Fig 1. On-Region Characteristics

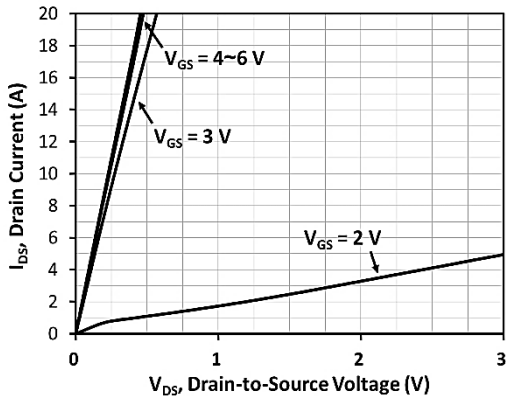

Fig 2. On-Resistance vs Drain Current and Temperature

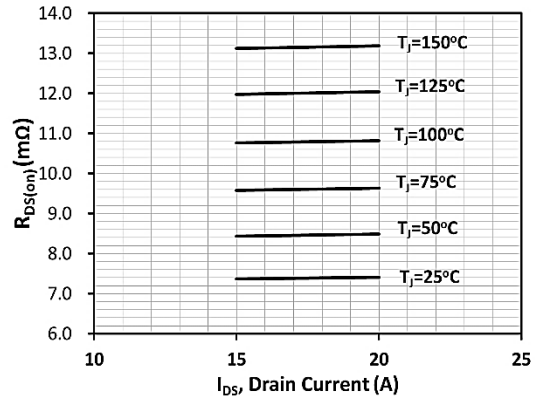

Fig 3. On-Resistance with Drain Current

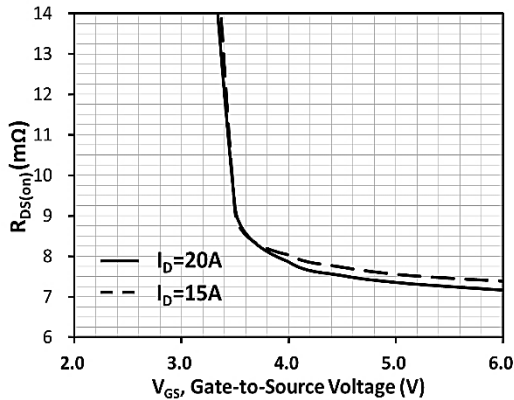

Fig 4. On-Resistance Variation with Temperature

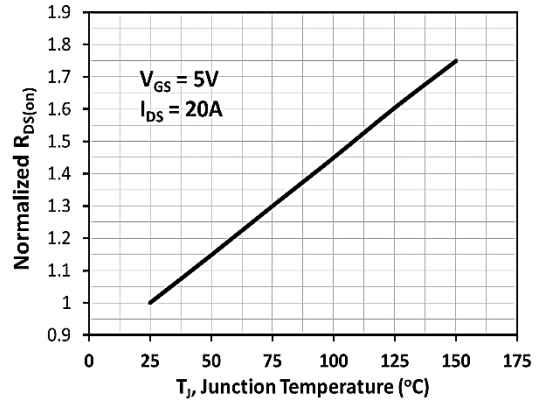

Fig 5. Threshold Voltage with Temperature

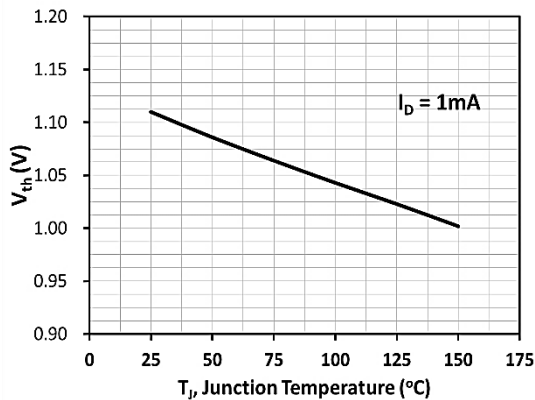

Fig 6. Capacitance Characteristics

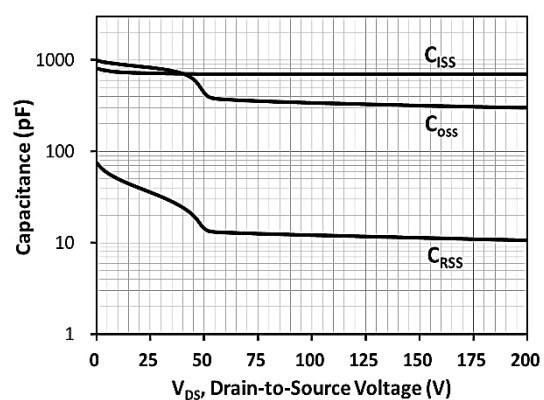

Fig 7. Gate Charge Characteristics, Qg

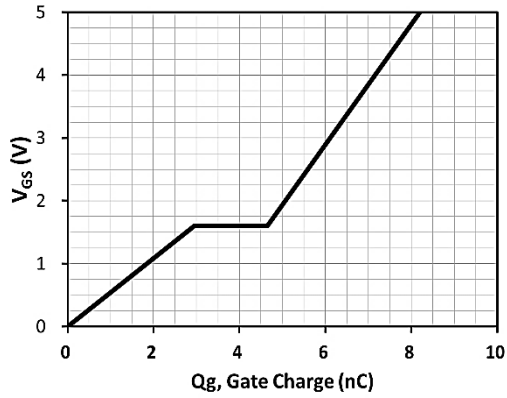
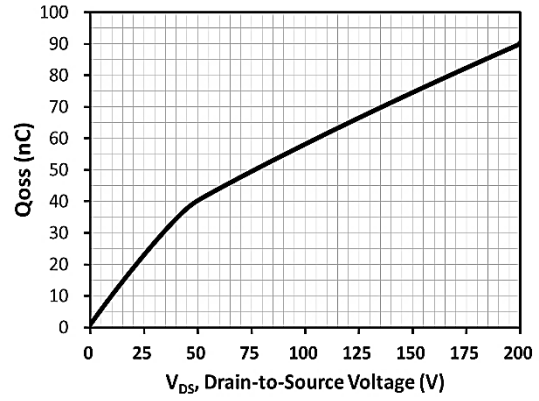
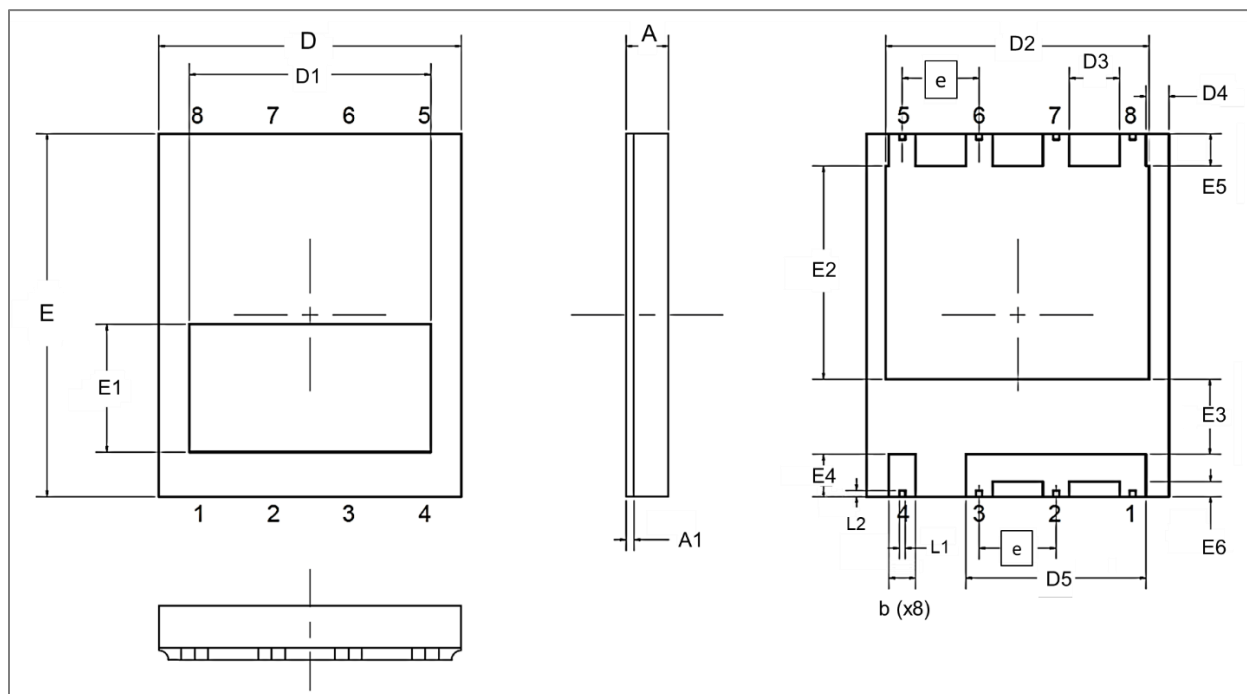

Fig 8. Capacitance Characteristics, Qoss



3- Package Outline Dimensions



➤ Table 4 Dimension of GR-RQFN-5x6-8L

SYMBOL	DIMENSION (IN MM)			SYMBOL	DIMENSION (IN MM)		
	MIN.	NOM.	MAX.		MIN.	NOM.	MAX.
A	---	---	0.70	D5	2.88	2.98	3.08
A1	0.13			E1	2.112 REF		
A2	0.42	0.45	0.48	E2	3.43	3.53	3.63
D	4.90	5.00	5.10	E3	1.14	1.24	1.34
E	2.90	6.00	3.10	E4	0.60	0.70	0.80
e	1.270 BSC			E5	0.43	0.53	0.63
b	0.34	0.44	0.54	E6	0.15	0.25	0.35
D1	3.994 REF			L1	0.05	0.10	0.20
D2	4.25	4.35	4.45	L2	0.05	0.10	0.20
D3	0.73	0.83	0.93				
D4	0.275	0.375	0.475				

4- Recommended PCB footprint

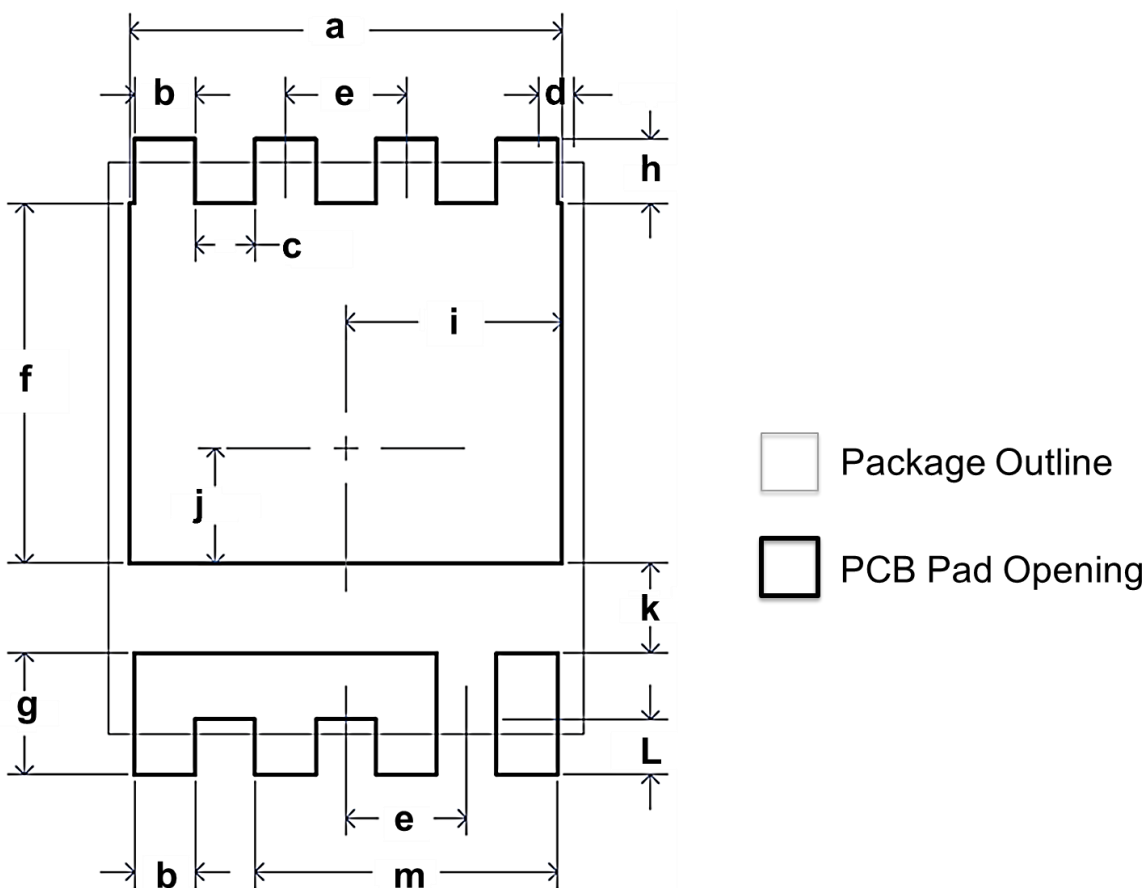

➤ Table 5 PCB Footprint Dimension

SYMBOL	DIMENSION	SYMBOL	DIMENSION
a	4.550	h	0.680
b	0.640	i	2.275
c	0.630	j	1.210
d	0.375	k	0.940
e	1.270	L	0.580
f	3.780	m	3.180
g	1.280	-	-

Notes:

(1) All dimensions are in mm.

(2) Drawing is not to Scale.

5- Change Log

Version	Date	Description
0.1	March 28, 2025	Initial version
0.2	October 22, 2025	Revised electrical characteristic curves.
0.3	April 16, 2026	Electrical characteristics revised

- **Note:** GaNrich semiconductor reserves the right to revise products and/or specifications without notice.