

GR-10E005UG: E-mode GaN Power Transistor

Description

GR-10E005UG is an enhancement mode GaN on Silicon power transistor. GR-10E005UG provides, high current and high operating speed which is suitable for DC to DC power supply applications.

Key Specifications

Part Number	GR-10E005UG
V _{DSS} , min.	100V
I _{DS} , Pulse (25°C, TPULSE = 300 μs)	90A
R _{DS(ON)} , typ. @V _{gs} =5V	5.2mΩ
Q _G , typ.	14.0nC

Features

- 100V enhancement mode power transistor
- High operating frequency
- R_{DS(on)} = Typ. 5.2 mΩ
- Dual-side cooled package
- HS compliant

Applications

- Switch Mode Power Supplies (SMPS)
- DC-DC Converters
- Fast Battery Charging
- Appliance Motor Drives

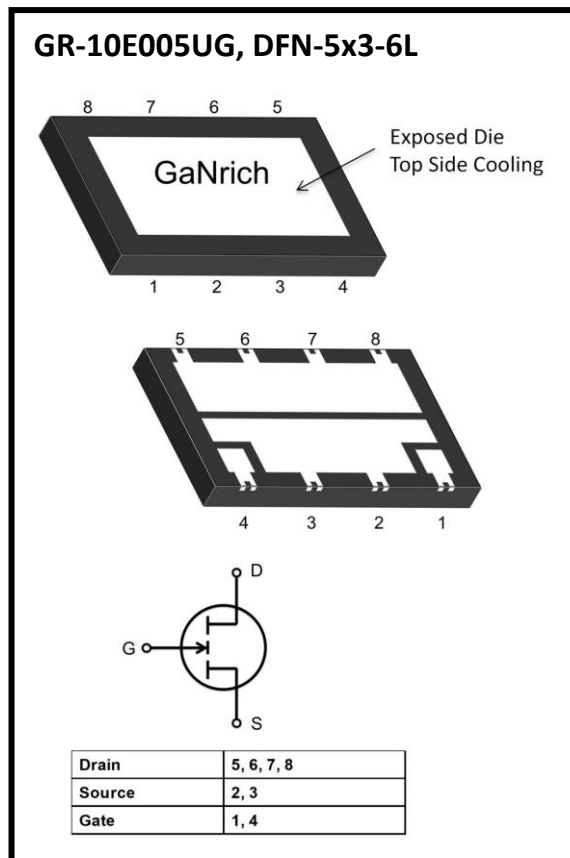

1. Electrical Characteristics

➤ **Table 1 Absolute maximum ratings**

Symbol	Parameter	Value	Unit
V_{DSS}	Drain-source voltage	100	V
$V_{(TR)DSS}$	Transient drain to source voltage ^a	120	V
V_{GSS}	Gate- source voltage	-6V ~ +6V	V
I_D	Drain current (continuous) at $T_C = 25^\circ\text{C}$ operation	33	A
	Drain current (continuous) at $T_C = 100^\circ\text{C}$ operation	22.8	A
$I_{D,Pulse}$	Pulsed drain current (pulse width: 300 μs , $V_{gs}=5\text{V}$) ^b	90	A
T_J	Operating temperature	-40 to +150	$^\circ\text{C}$
T_S	Storage temperature	-40 to +150	$^\circ\text{C}$
MSL	Mousture sensitivity level	MSL3	

- a. In off-state, spike duty cycle $D < 0.01$, spike duration $< 1\mu\text{s}$
- b. Defined by product design and characterization. Value is not tested to full current in production

➤ **Table 2 Thermal Characteristics**

Symbol	Parameter	Value	Unit
$R_{\theta JC_Top}$	Thermal resistance junction-case, Top	0.50	$^\circ\text{C}/\text{W}$
$R_{\theta JC_Bot}$	Thermal resistance junction-case, Bottom	0.50	$^\circ\text{C}/\text{W}$
$R_{\theta JA}$	Thermal resistance junction-ambient	60	$^\circ\text{C}/\text{W}$

- a. Tested in package DFN 5x3.

➤ **Table 3 Electrical Characteristics** ($T_{CASE} = 25\text{ }^{\circ}\text{C}$ unless otherwise stated)

Symbol	Parameter	Conditions	Values			Unit
			min.	typ.	max.	
V_{DSS}	Drain-source voltage	$V_{GS} = 0V, I_D = 150\mu A$	100	-	-	V
$V_{GS(th)}$	Gate threshold voltage	$V_{DS} = V_{GS}, I_D = 15mA$	0.8	1.7	2.3	V
$R_{DS(on)}$	Static drain-source on-resistance	$V_{GS} = 5V, I_D = 50A$	-	5.2	6.8	m Ω
I_{DSS}	Drain-source leakage current	$V_{DS} = 80V, V_{GS} = 0V$	-	5.0	400	μA
I_{GSS}	Gate-to-Source Forward Leakage current	$V_{GS} = +5V$	-	0.05	10	mA
	Gate-to-Source Forward Leakage current	$V_{GS} = +5V, T_J = 125^{\circ}\text{C}$	-	0.55	16.5	mA
	Gate-to-Source Reverse Leakage current	$V_{GS} = -4V$	-	1.20	36.0	μA
C_{ISS}	Input capacitance	$V_{DS} = 50V, V_{GS} = 0V$	-	823	-	pF
C_{OSS}	Output capacitance		-	439	-	
C_{RSS}	Reverse transfer capacitance		-	31.9	-	
Q_G	Gate charge	$V_{DS} = 50V, V_{GS} = 5V, I_D = 50A$	-	14.0	-	nC
Q_{GS}	Gate-source charge	$V_{DS} = 50V, I_D = 50A$	-	5.2	-	
Q_{GD}	Gate-drain charge		-	2.1	-	
Q_{OSS}	Output charge	$V_{DS} = 50V, V_{GS} = 0V$	-	34.7	-	
Q_{RR}	Reverse recovery charge	-	-	0	-	

2- Typical Characteristic Curves

Fig 1. On-Region Characteristics

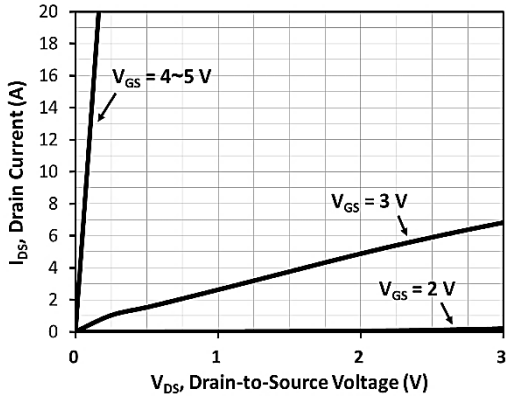

Fig 2. On-Resistance vs Drain Current and Temperature

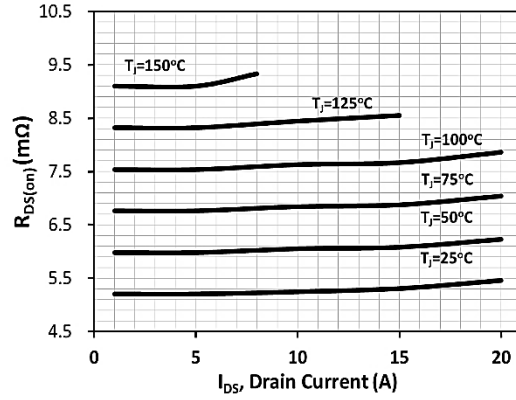

Fig 3. On-Resistance with Drain Current

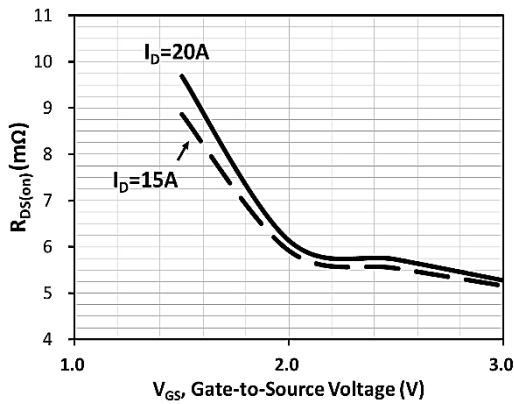

Fig 4. On-Resistance Variation with Temperature

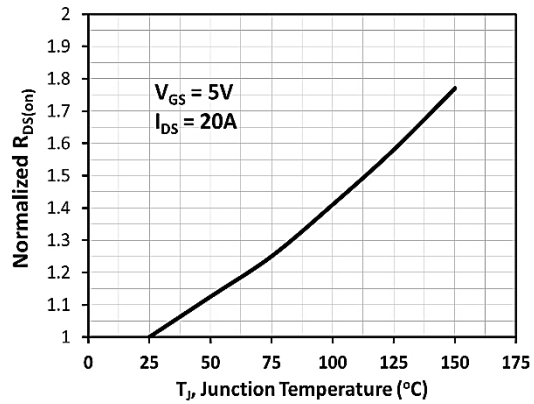

Fig 5. Threshold Voltage with Temperature

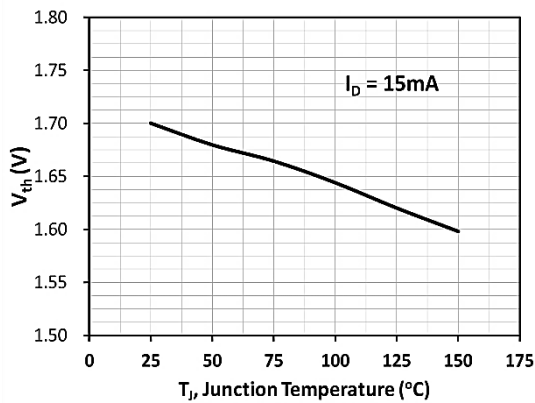

Fig 6. Capacitance Characteristics

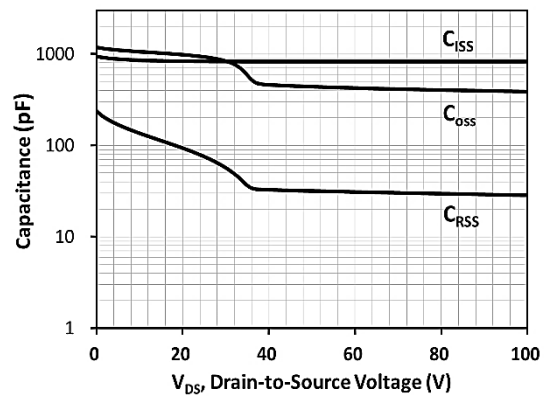

Fig 7. Gate Charge Characteristics, Qg

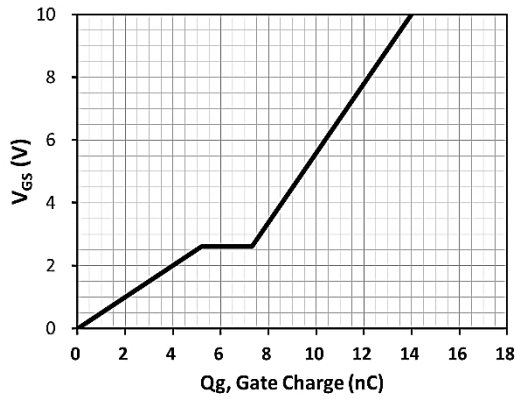
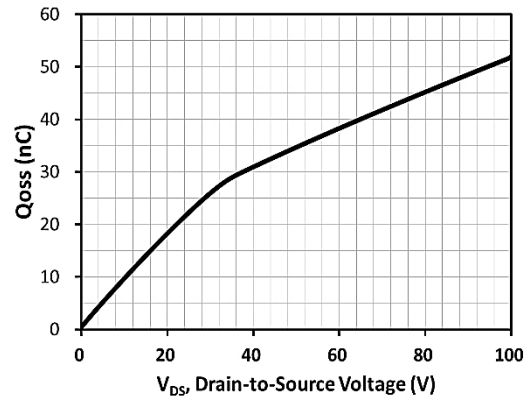
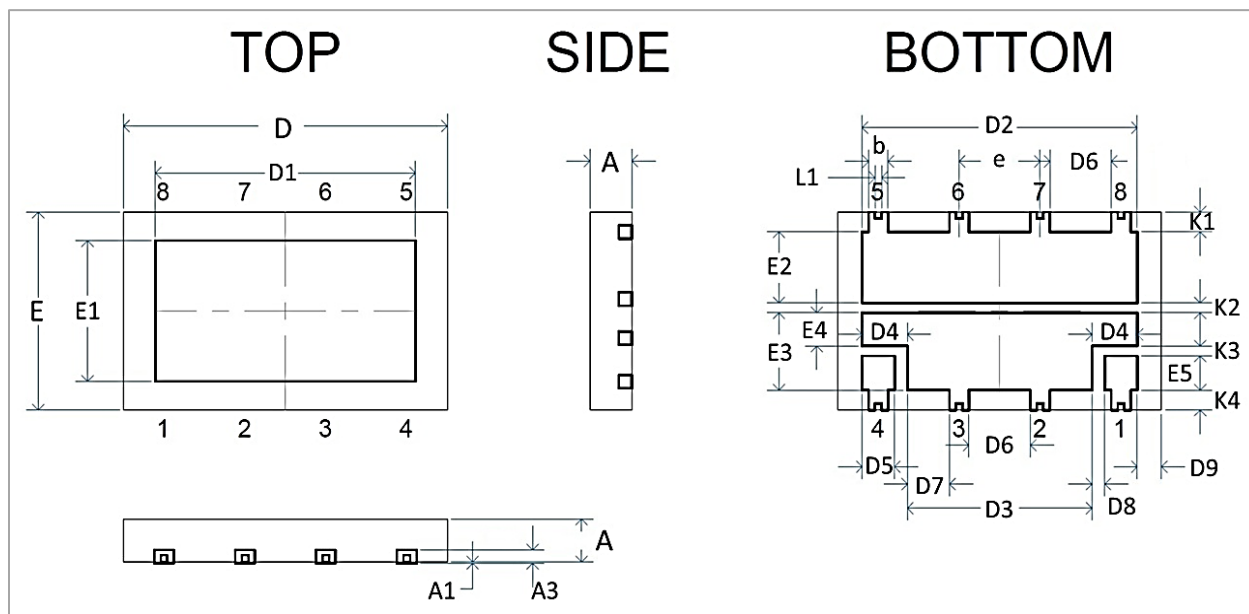

Fig 8. Capacitance Characteristics, Qoss



3. Package Outline Dimensions





➤ Table 4 Dimension of GR-DFN-5x3-6L

SYMBOL	DIMENSION (MM)			SYMBOL	DIMENSION (IN MM)		
	MIN.	NOM.	MAX.		MIN.	NOM.	MAX.
A	0.60	0.65	0.70	D7	0.55	0.65	0.75
A2	--	0.02	0.05	D8	0.10	0.20	0.30
A3	0.203 REF			D9	0.365	0.375	0.385
D	4.90	5.00	5.10	E1	2.132 REF		
E	2.90	3.00	3.10	E2	0.976	1.076	1.176
e	1.25 BSC			E3	1.074	1.174	1.274
b	0.20	0.30	0.40	E4	0.405	0.505	0.605
D1	4.018 REF			E5	0.419	0.519	0.619
D2	4.15	4.25	4.35	K1	0.20	0.30	0.40
D3	2.75	2.85	2.95	K2	0.05	0.15	0.25
D4	0.60	0.70	0.80	K3	0.05	0.15	0.25
D5	0.40	0.50	0.60	K4	0.20	0.30	0.40
D6	0.85	0.95	1.05				

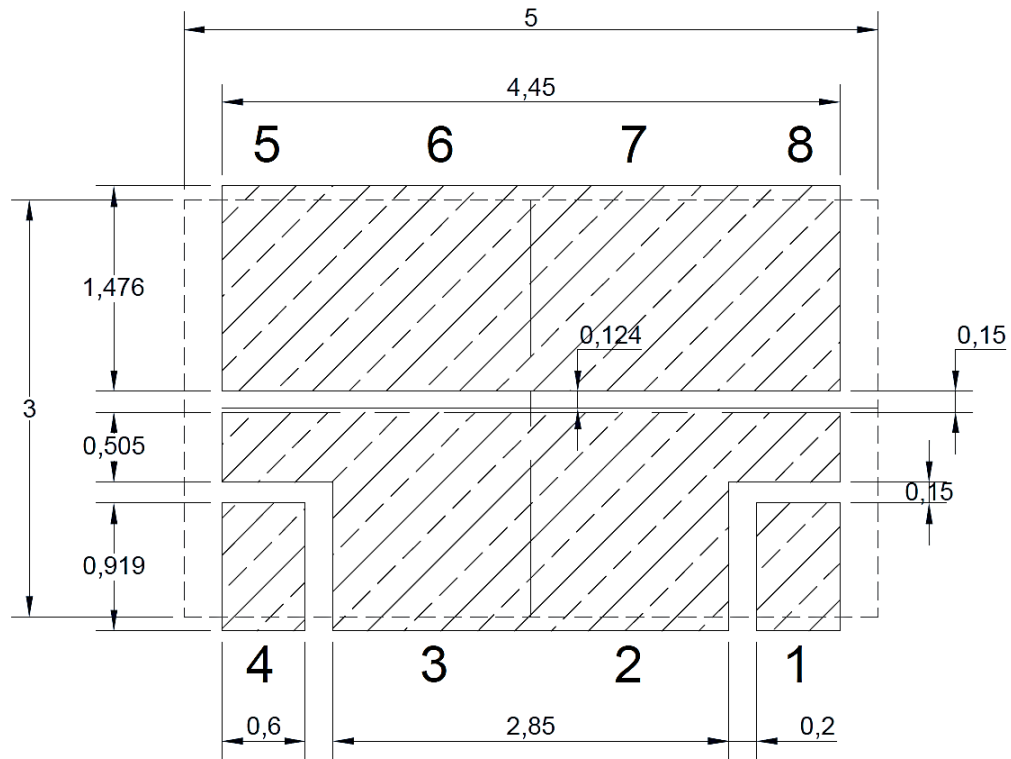
Recommended PCB Soldering footprint



-  Package outlines
-  PCB pad openings

4. Tape and reel Information

13" Reel, Carrier Tape W=12mm

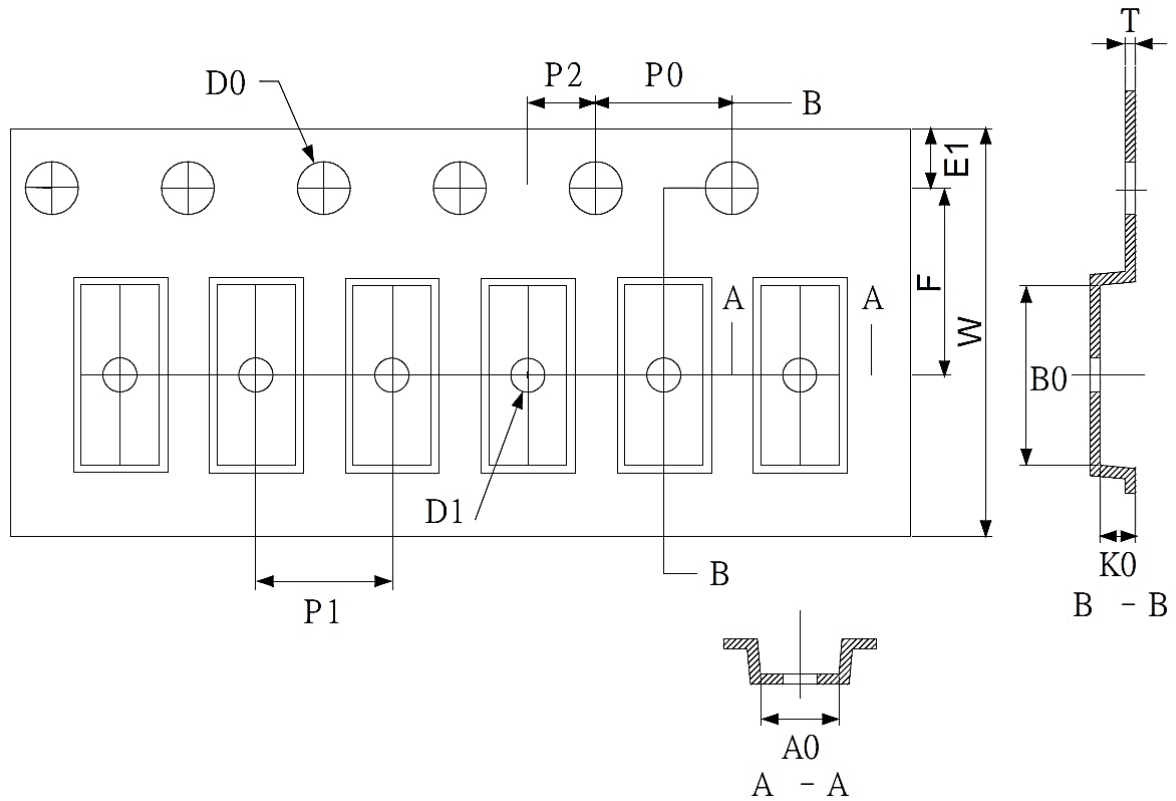

Application	A	H	T1	C	d	D	W	E1	F
DFN 3x5_EP	180 ± 0.1	50 min.	13.2 ± 0.2	13.0 ± 0.2	1.5 min.	21.0 ± 0.4	12.0 ± 0.3	1.75 ± 0.1	5.5 ± 0.1
	P0	P1	P2	D0	D1	T	A0	B0	K0
Unit: mm	4.0 ± 0.1	4.0 ± 0.1	2.0 ± 0.05	1.55 ± 0.1	1.0 ± 0.1	0.3 ± 0.05	2.3 ± 0.2	5.3 ± 0.2	1.0 ± 0.1

13" Reel, Carrier Tape W=12mm

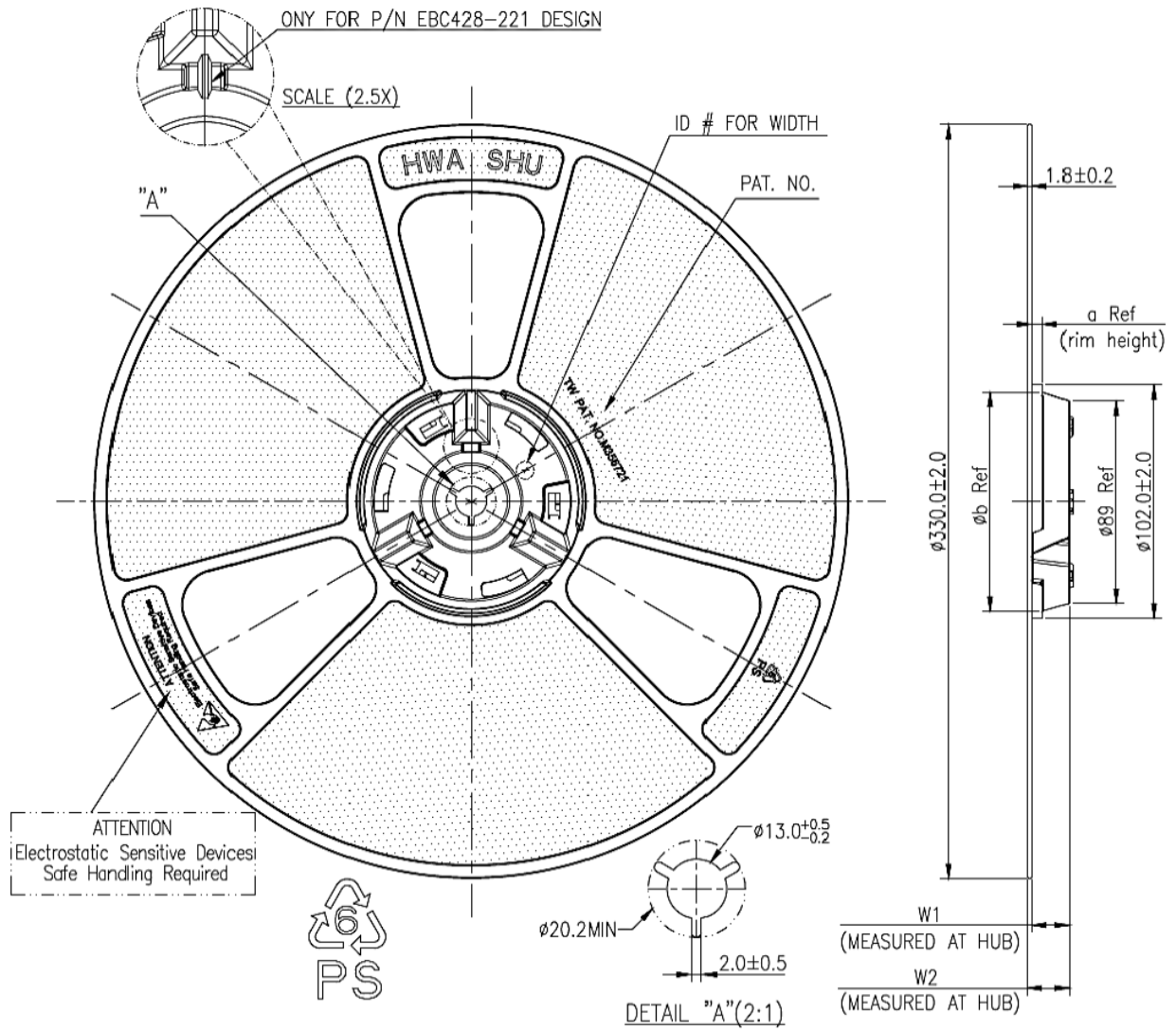

5. Change Log

Version	Date	Description
0.1	Feb 05, 2025	Initial version
0.2	SEPT 26, 2025	Electrical characteristics, Curve information revised.
0.3	Apr 16, 2026	Electrical characteristics revised.

- **Note:** GaNrich semiconductor reserves the right to revise products and/or specifications without notice.